

Ecoline is a luminaire series with wall washer, asymmetric, narrow or wide beam light distribution and comes in various different lengths. In addition to stand alone luminaires, there is also a modular system for creating continuous lines with hardly any shadow between the modules. A combination of innovative light sources and precise optical systems brought together to form an economical and low-maintenance lighting system.

Despite having integral control gear, the cross section of these luminaires is extremely small. This enables them to be used very discretely in any architectural situation.

Ecoline Mini complements the Ecoline series with products of even more compact dimensions. They are the smallest linear products on the market with integral driver, for direct connection to mains voltage.



The narrow beam versions produce an intensive grazing effect above the longitudinal axis of the luminaire.



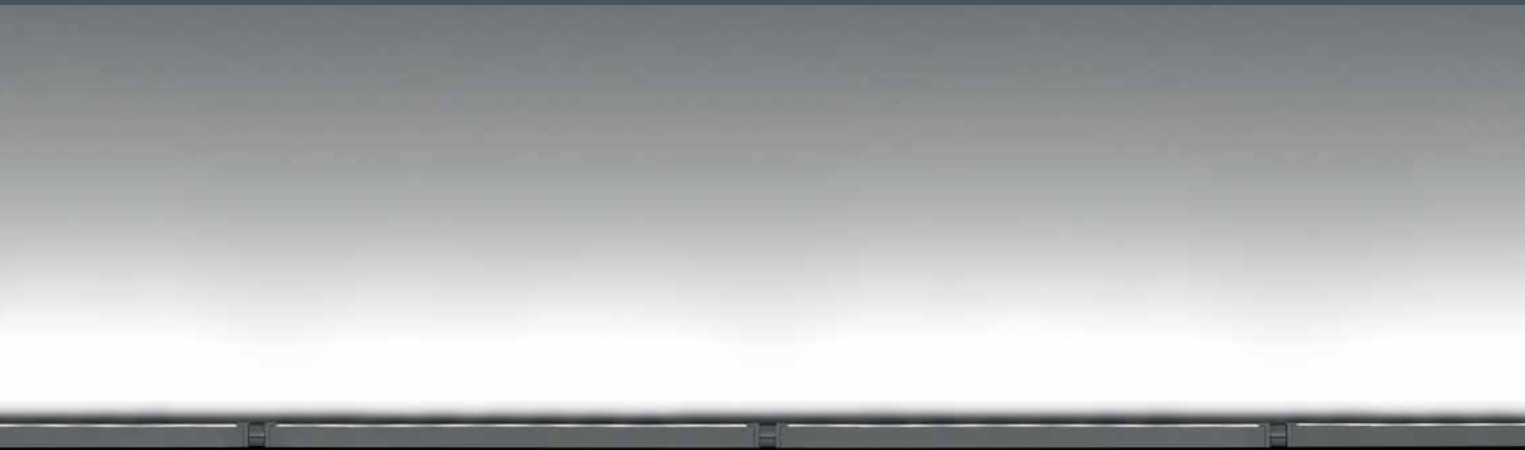

Design: Roy Fleetwood



The precise optics produce wall washer, asymmetrical or narrow beam distribution.



TownFence® Werbebanner, Munich/Germany
TownTalker Media AG, Cologne

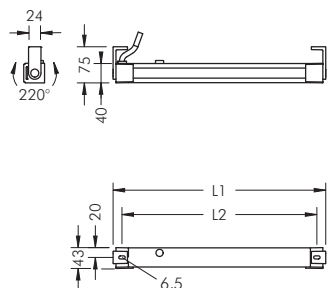

Ecoline Mini

With high performance LEDs, integral temperature monitoring device, CRI: > 80, Colour tolerance: max. 2 SDCM Service life: L90/B10 > 50 000 h protection class I, IP65 \diamond \triangle \triangle , IK10 housing made of extruded aluminium and corrosion-resistant die cast aluminium AlSi12, polyester powder coated, all exterior steel parts are stainless steel, polycarbonate cover, silicon gasket, mounting flanges: 2 elongated holes \varnothing 6.5 mm, spacing L2, tilt range 220°, M16 cable gland, with 1 m cable H05RN-F3G1 attached, integral driver (AC/DC)

Ecoline Mini, wall washer, L1 = 444 mm, L2 = 407 mm

Part number	Colour	Weight	Light source	Luminous flux	Beam angle γ (FWHM)	
8 766 946 009	black	1.1 kg	3 x LED 1.8 W	293 lm	C 0 – 180	C 90 – 270
8 766 966 009	white		(5 W)		20°	88°
8 766 956 009	silver grey		warm white (3000 K)			

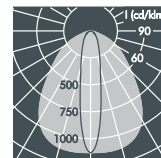
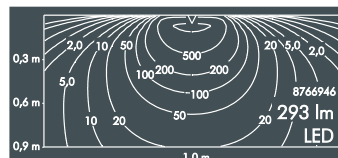

Part number	Colour	Weight	Light source	Luminous flux	Beam angle γ (FWHM)	
8 766 945 009	black	1.1 kg	3 x LED 1.8 W	308 lm	C 0 – 180	C 90 – 270
8 766 965 009	white		(5 W)		20°	88°
8 766 955 009	silver grey		neutral white (4000 K)			

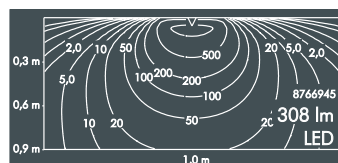

Ecoline Mini, wall washer, L1 = 668 mm, L2 = 631 mm

Part number	Colour	Weight	Light source	Luminous flux	Beam angle γ (FWHM)	
8 766 046 009	black	1.5 kg	6 x LED 1.8 W	585 lm	C 0 – 180	C 90 – 270
8 766 066 009	white		(11 W)		20°	88°
8 766 056 009	silver grey		warm white (3000 K)			

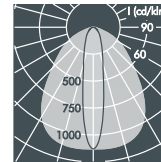
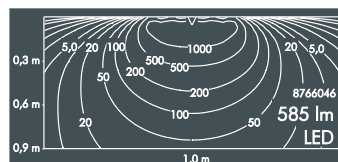

Part number	Colour	Weight	Light source	Luminous flux	Beam angle γ (FWHM)	
8 766 045 009	black	1.5 kg	6 x LED 1.8 W	614 lm	C 0 – 180	C 90 – 270
8 766 065 009	white		(11 W)		20°	88°
8 766 055 009	silver grey		neutral white (4000 K)			

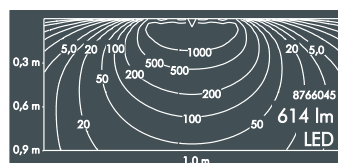

Ecoline Mini, wall washer, L1 = 962 mm, L2 = 925 mm

Part number	Colour	Weight	Light source	Luminous flux	Beam angle γ (FWHM)	
8 766 146 009	black	2.1 kg	9 x LED 1.8 W	878 lm	C 0 – 180	C 90 – 270
8 766 166 009	white		(16 W)		20°	88°
8 766 156 009	silver grey		warm white (3000 K)			

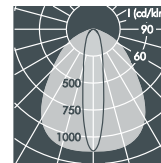
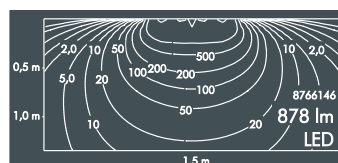

Part number	Colour	Weight	Light source	Luminous flux	Beam angle γ (FWHM)	
8 766 145 009	black	2.1 kg	9 x LED 1.8 W	922 lm	C 0 – 180	C 90 – 270
8 766 165 009	white		(16 W)		20°	88°
8 766 155 009	silver grey		neutral white (4000 K)			

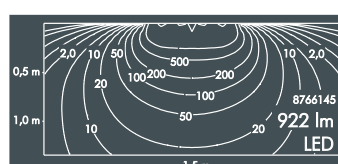

Part number	Description
. 1..	Dimmable luminaire (DALI)
. 2..	Dimmable luminaire (1-10 V)

* Not available for luminaire L1 = 444 mm

LED (see page 215)

luminaires available in 2700 K and other colour temperatures upon request

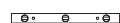

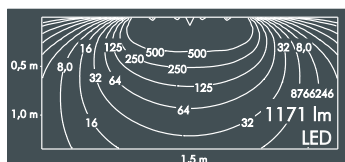
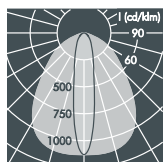

Ecoline Mini, wall washer, L1 = 1256 mm, L2 = 1219 mm

Part number	Colour	Weight	Light source	Luminous flux	Beam angle γ (FWHM)	
8 766 246 009	black	2.5 kg	12 x LED 1.8 W (22 W) warm white (3000 K)	1171 lm	C 0 – 180	C 90 – 270
8 766 266 009	white				20°	88°
8 766 256 009	silver grey					

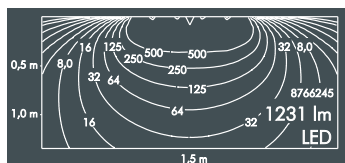

Part number	Colour	Weight	Light source	Luminous flux	Beam angle γ (FWHM)	
8 766 245 009	black	2.5 kg	12 x LED 1.8 W (22 W) neutral white (4000 K)	1231 lm	C 0 – 180	C 90 – 270
8 766 265 009	white				20°	88°
8 766 255 009	silver grey					

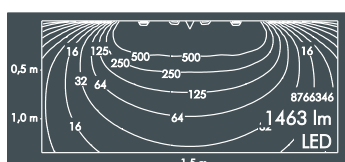
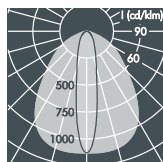

Ecoline Mini, wall washer, L1 = 1550 mm, L2 = 1513 mm

Part number	Colour	Weight	Light source	Luminous flux	Beam angle γ (FWHM)	
8 766 346 009	black	3.0 kg	15 x LED 1.8 W (27 W) warm white (3000 K)	1463 lm	C 0 – 180	C 90 – 270
8 766 366 009	white				20°	88°
8 766 356 009	silver grey					

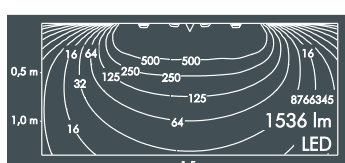

Part number	Colour	Weight	Light source	Luminous flux	Beam angle γ (FWHM)	
8 766 345 009	black	3.0 kg	15 x LED 1.8 W (27 W) neutral white (4000 K)	1536 lm	C 0 – 180	C 90 – 270
8 766 365 009	white				20°	88°
8 766 355 009	silver grey					



Ecoline Mini, asymmetrical beam**

Part number	Description
. 8.	Luminaires with asymmetrical distribution

** The luminaires are available in 5 different lengths.

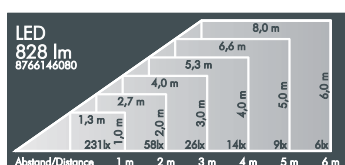
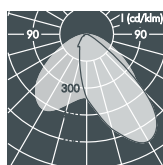

Ecoline Mini, asymmetrical beam, L1 = 962 mm, L2 = 925 mm

Part number	Colour	Weight	Light source	Luminous flux	Main beam angle γ
8 766 146 089	black	2.1 kg	9 x LED 1.8 W (16 W) warm white (3000 K)	828 lm	30°
8 766 166 089	white				
8 766 156 089	silver grey				

Part number	Description
. 1..	Dimmable luminaire (DALI)
. 2..	Dimmable luminaire (1-10 V)

* Not available for luminaire L1 = 444 mm

LED (see page 215)

Luminaires available in 2700 K and other colour temperatures upon request

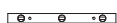

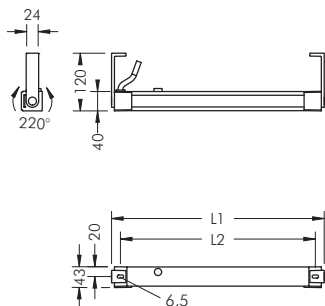

Ecoline Mini with wall arms

With high performance LEDs, integral temperature monitoring device, CRI: > 80, Colour tolerance: max. 2 SDCM
 Service life: L90/B10 > 50 000 h
 protection class I, IP65 , IK10
 housing made of extruded aluminium and corrosion-resistant die cast aluminium AlSi12, polyester powder coated, all exterior steel parts are stainless steel, polycarbonate cover, silicon gasket, wall arms: 2 elongated holes \varnothing 6.5 mm, spacing L2, tilt range 220°, M16 cable gland, with 1 m cable H05RN-F3G1 attached, integral driver (AC/DC)

Ecoline Mini, wall washer with wall arms, L1 = 444 mm, L2 = 407 mm

Part number	Colour	Weight	Light source	Luminous flux	Beam angle γ (FWHM)	
8 767 946 009	black	1.1 kg	3 x LED 1.8 W (5 W)	293 lm	C 0 – 180	C 90 – 270
8 767 966 009	white				20°	88°
8 767 956 009	silver grey				warm white (3000 K)	

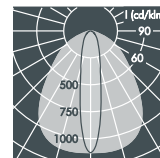
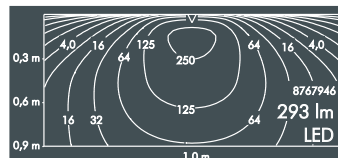

Part number	Colour	Weight	Light source	Luminous flux	Beam angle γ (FWHM)	
8 767 945 009	black	1.1 kg	3 x LED 1.8 W (5 W)	308 lm	C 0 – 180	C 90 – 270
8 767 965 009	white				20°	88°
8 767 955 009	silver grey				neutral white (4000 K)	

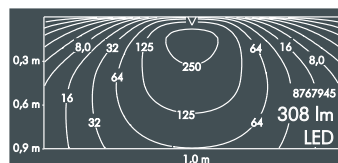

Ecoline Mini, wall washer with wall arms, L1 = 668 mm, L2 = 631 mm

Part number	Colour	Weight	Light source	Luminous flux	Beam angle γ (FWHM)	
8 767 046 009	black	1.5 kg	6 x LED 1.8 W (11 W)	585 lm	C 0 – 180	C 90 – 270
8 767 066 009	white				20°	88°
8 767 056 009	silver grey				warm white (3000 K)	

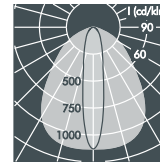
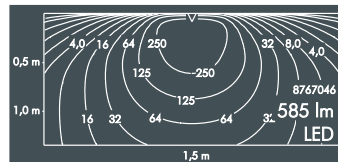

Part number	Colour	Weight	Light source	Luminous flux	Beam angle γ (FWHM)	
8 767 045 009	black	1.5 kg	6 x LED 1.8 W (11 W)	614 lm	C 0 – 180	C 90 – 270
8 767 065 009	white				20°	88°
8 767 055 009	silver grey				neutral white (4000 K)	

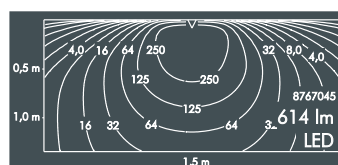

Ecoline Mini, wall washer with wall arms, L1 = 962 mm, L2 = 925 mm

Part number	Colour	Weight	Light source	Luminous flux	Beam angle γ (FWHM)	
8 767 146 009	black	2.1 kg	9 x LED 1.8 W (16 W)	878 lm	C 0 – 180	C 90 – 270
8 767 166 009	white				20°	88°
8 767 156 009	silver grey				warm white (3000 K)	

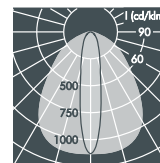
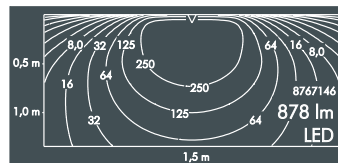

Part number	Colour	Weight	Light source	Luminous flux	Beam angle γ (FWHM)	
8 767 145 009	black	2.1 kg	9 x LED 1.8 W (16 W)	922 lm	C 0 – 180	C 90 – 270
8 767 165 009	white				20°	88°
8 767 155 009	silver grey				neutral white (4000 K)	

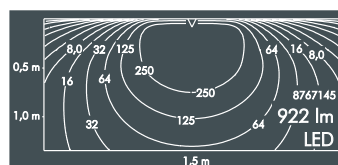

Part number	Description
. 1..	Dimmable luminaire (DALI)
. 2..	Dimmable luminaire (1-10 V)

* Not available for luminaire L1 = 444 mm

LED (see page 247)

luminaires available in 2700 K and other colour temperatures upon request

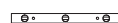

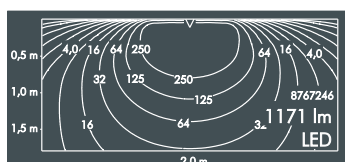
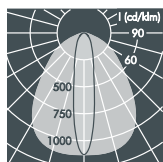

Ecoline Mini, wall washer with wall arms, L1 = 1256 mm, L2 = 1219 mm

Part number	Colour	Weight	Light source	Luminous flux	Beam angle γ (FWHM)	
8 767 246 009	black	2.5 kg	12 x LED 1.8 W (22 W)	1171 lm	C 0 – 180	C 90 – 270
8 767 266 009	white				20°	88°
8 767 256 009	silver grey				warm white (3000 K)	

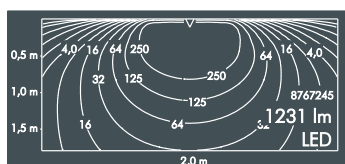

Part number	Colour	Weight	Light source	Luminous flux	Beam angle γ (FWHM)	
8 767 245 009	black	2.5 kg	12 x LED 1.8 W (22 W)	1231 lm	C 0 – 180	C 90 – 270
8 767 265 009	white				20°	88°
8 767 255 009	silver grey				neutral white (4000 K)	

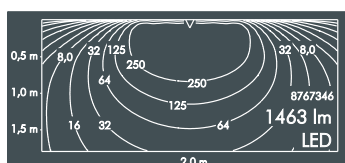
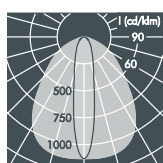

Ecoline Mini, wall washer with wall arms, L1 = 1550 mm, L2 = 1513 mm

Part number	Colour	Weight	Light source	Luminous flux	Beam angle γ (FWHM)	
8 767 346 009	black	3.0 kg	15 x LED 1.8 W (27 W)	1463 lm	C 0 – 180	C 90 – 270
8 767 366 009	white				20°	88°
8 767 356 009	silver grey				warm white (3000 K)	

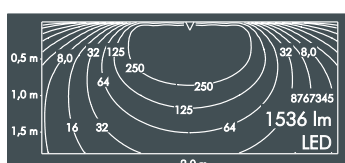

Part number	Colour	Weight	Light source	Luminous flux	Beam angle γ (FWHM)	
8 767 345 009	black	3.0 kg	15 x LED 1.8 W (27 W)	1536 lm	C 0 – 180	C 90 – 270
8 767 365 009	white				20°	88°
8 767 355 009	silver grey				neutral white (4000 K)	

Part number	Description
• • • • • 1 • •	Dimmable luminaire (DALI)
• • • • • 2 • •	Dimmable luminaire (1-10 V)

* Not available for luminaire L1 = 444 mm

LED (see page 247)

Luminaires available in 2700 K and other colour temperatures upon request

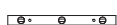



Ecoline Mini S Modular System

The luminaire modules are joined together in continuous runs. The luminaire system is installed using either wall flanges or wall arms. The wall arms increase the distance between the luminaire and the surface to be illuminated, thus increasing the uniformity of light distribution.

Regardless of the number of luminaires to be connected, just 1 wall flange set **or** 1 wall arm set is required to mount the outer left and right hand luminaires, SL and SR, to the surface.

Mounting components for Ecoline Mini S Modular System		
Part number	Colour	Description
127 0 392 940	black	Wall flange set, (pair) for outer luminaires
127 0 392 960	white	
127 0 392 950	silver grey	

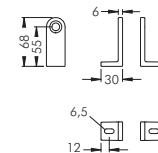

Mounting components for Ecoline Mini S Modular System		
Part number	Colour	Description
127 0 393 940	black	Wall arm set, (pair) for outer luminaires, length 100 mm
127 0 393 960	white	
127 0 393 950	silver grey	

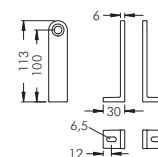

To connect two luminaires together, either one connection flange **or** one connection arm is required. The number of these connection parts required equals the total number of luminaires minus 1.

Mounting components for Ecoline Mini S Modular System		
Part number	Colour	Description
127 0 390 940	black	Connection flange, to connect two luminaires
127 0 390 960	white	
127 0 390 950	silver grey	

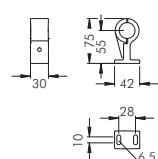

Mounting components for Ecoline Mini S Modular System		
Part number	Colour	Description
127 0 391 940	black	Connection arm, to connect two luminaires, length 100 mm
127 0 391 960	white	
127 0 391 950	silver grey	

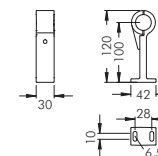

The Modular System

Luminaires of different lengths and wattages can be connected together. One left (SL) and one right (SR) luminaire are always required. In addition to these, middle luminaires (SM) can be added to the system.

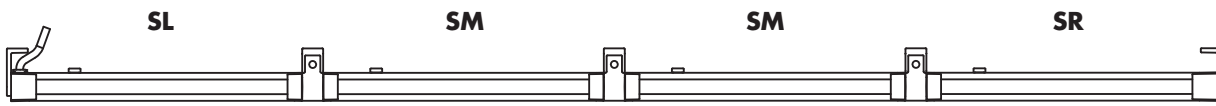
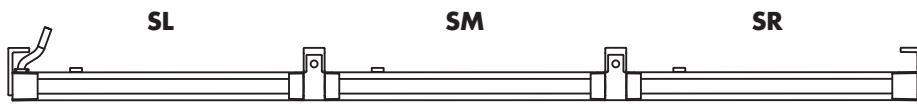
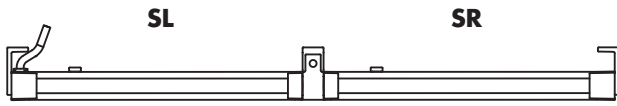

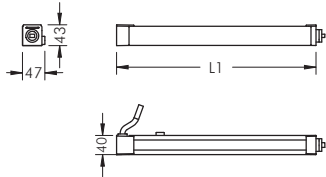

Ecoline Mini SL Modular System, left

With high performance LEDs, integral temperature monitoring device, CRI: > 80, Colour tolerance: max. 2 SDCM Service life: L90/B10 > 50 000 h protection class I, IP65 $\diamond \triangle \triangle$, IK10 housing made of extruded aluminium and corrosion-resistant die cast aluminium AlSi12, polyester powder coated, all exterior steel parts are stainless steel, polycarbonate cover, silicon gasket, with connection coupling and 3-pin connector on right, tilt range 220°, M16 cable gland, with 1 m cable H05RN-F3G1 attached, integral driver (AC/DC)

Ecoline Mini SL, left, wall washer, L1 = 641 mm

Part number	Colour	Weight	Light source	Luminous flux	Beam angle γ (FWHM)	
8 768 046 009	black	1.5 kg	6 x LED 1.8 W (11 W)	585 lm	C 0 - 180	C 90 - 270
8 768 066 009	white				20°	88°
8 768 056 009	silver grey					

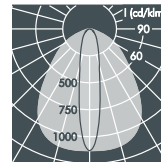

Ecoline Mini SL, left, wall washer, L1 = 935 mm

Part number	Colour	Weight	Light source	Luminous flux	Beam angle γ (FWHM)	
8 768 146 009	black	2.1 kg	9 x LED 1.8 W (16 W)	878 lm	C 0 - 180	C 90 - 270
8 768 166 009	white				20°	88°
8 768 156 009	silver grey					

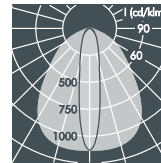

Ecoline Mini SL, left, wall washer, L1 = 1229 mm

Part number	Colour	Weight	Light source	Luminous flux	Beam angle γ (FWHM)	
8 768 246 009	black	2.5 kg	12 x LED 1.8 W (22 W)	1171 lm	C 0 - 180	C 90 - 270
8 768 266 009	white				20°	88°
8 768 256 009	silver grey					

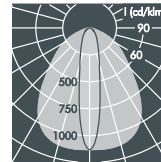

Ecoline Mini SL, left, wall washer, L1 = 1523 mm

Part number	Colour	Weight	Light source	Luminous flux	Beam angle γ (FWHM)	
8 768 346 009	black	3.0 kg	15 x LED 1.8 W (27 W)	1463 lm	C 0 - 180	C 90 - 270
8 768 366 009	white				20°	88°
8 768 356 009	silver grey					

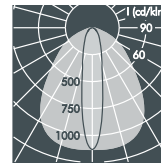

Ecoline Mini SL, left, wall washer

Part number	Description
. 5 . . .	Luminaire with neutral white colour temperature (4000 K)
. 1 . .	Dimmable luminaire (DALI)
. 2 . .	Dimmable luminaire (1-10 V)

The luminaires can be supplied with asymmetrical light distribution upon request.

LED (see page 247)

Luminaires available in 2700 K and other colour temperatures upon request

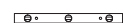

Ecoline Mini SM Modular System, middle

With high performance LEDs,
integral temperature monitoring device,
CRI: > 80, Colour tolerance: max. 2 SDCM
Service life: L90/B10 > 50 000 h
protection class I, IP65 , IK10
housing made of extruded aluminium and
corrosion-resistant die cast aluminium AlSi12,
polyester powder coated,
all exterior steel parts are stainless steel,
polycarbonate cover, silicon gasket,
with connection coupling and
3-pin connector on left and right,
tilt range 220°,
integral driver (AC/DC)

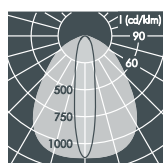
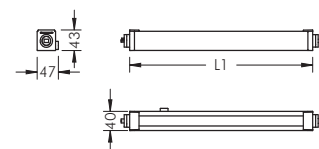

Ecoline Mini SM, middle, wall washer, L1 = 625 mm

Part number	Colour	Weight	Light source	Luminous flux	Beam angle γ (FWHM)	
8 769 046 009	black	1.5 kg	6 x LED 1.8 W (11 W) warm white (3000 K)	585 lm	C 0 – 180	C 90 – 270
8 769 066 009	white				20°	88°
8 769 056 009	silver grey					

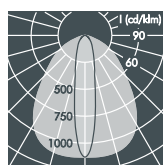

Ecoline Mini SM, middle, wall washer, L1 = 919 mm

Part number	Colour	Weight	Light source	Luminous flux	Beam angle γ (FWHM)	
8 769 146 009	black	2.1 kg	9 x LED 1.8 W (16 W) warm white (3000 K)	878 lm	C 0 – 180	C 90 – 270
8 769 166 009	white				20°	88°
8 769 156 009	silver grey					

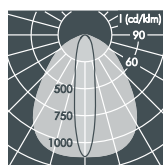

Ecoline Mini SM, middle, wall washer, L1 = 1213 mm

Part number	Colour	Weight	Light source	Luminous flux	Beam angle γ (FWHM)	
8 769 246 009	black	2.5 kg	12 x LED 1.8 W (22 W) warm white (3000 K)	1171 lm	C 0 – 180	C 90 – 270
8 769 266 009	white				20°	88°
8 769 256 009	silver grey					

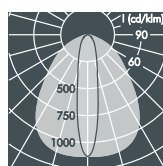

Ecoline Mini SM, middle, wall washer, L1 = 1507 mm

Part number	Colour	Weight	Light source	Luminous flux	Beam angle γ (FWHM)	
8 769 346 009	black	3.0 kg	15 x LED 1.8 W (27 W) warm white (3000 K)	1463 lm	C 0 – 180	C 90 – 270
8 769 366 009	white				20°	88°
8 769 356 009	silver grey					

Ecoline Mini SM, middle, wall washer

Part number	Description
... 5 ...	Luminaire with neutral white colour temperature (4000 K)
... 1 ..	Dimmable luminaire (DALI)
... 2 ..	Dimmable luminaire (1-10 V)

The luminaires can be supplied with asymmetrical light distribution upon request.

LED (see page 247)

Luminaires available in 2700 K and other colour temperatures upon request

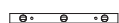

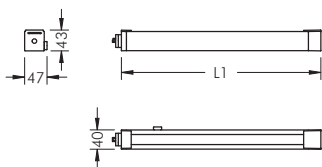

Ecoline Mini SR Modular System, right

With high performance LEDs, integral temperature monitoring device, CRI: > 80, Colour tolerance: max. 2 SDCM Service life: L90/B10 > 50 000 h protection class I, IP65 , IK10 housing made of extruded aluminium and corrosion-resistant die cast aluminium AlSi12, polyester powder coated, all exterior steel parts are stainless steel, polycarbonate cover, silicon gasket, with connection coupling and 3-pin connector on left, tilt range 220°, integral driver (AC/DC)

Ecoline Mini SR, right, wall washer, L1 = 641 mm

Part number	Colour	Weight	Light source	Luminous flux	Beam angle γ (FWHM)	
8 770 046 009	black	1.5 kg	6 x LED 1.8 W (11 W)	585 lm	C 0 – 180	C 90 – 270
8 770 066 009	white				20°	88°
8 770 056 009	silver grey					

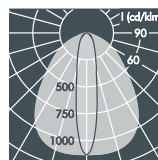

Ecoline Mini SR, right, wall washer, L1 = 935 mm

Part number	Colour	Weight	Light source	Luminous flux	Beam angle γ (FWHM)	
8 770 146 009	black	2.1 kg	9 x LED 1.8 W (16 W)	878 lm	C 0 – 180	C 90 – 270
8 770 166 009	white				20°	88°
8 770 156 009	silver grey					

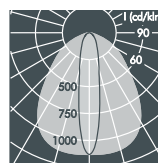

Ecoline Mini SR, right, wall washer, L1 = 1229 mm

Part number	Colour	Weight	Light source	Luminous flux	Beam angle γ (FWHM)	
8 770 246 009	black	2.5 kg	12 x LED 1.8 W (22 W)	1171 lm	C 0 – 180	C 90 – 270
8 770 266 009	white				20°	88°
8 770 256 009	silver grey					

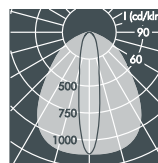

Ecoline Mini SR, right, wall washer, L1 = 1523 mm

Part number	Colour	Weight	Light source	Luminous flux	Beam angle γ (FWHM)	
8 770 346 009	black	3.0 kg	15 x LED 1.8 W (27 W)	1463 lm	C 0 – 180	C 90 – 270
8 770 366 009	white				20°	88°
8 770 356 009	silver grey					

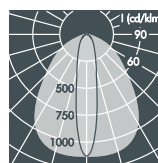

Ecoline Mini SR, right, wall washer

Part number	Description
. 5 . . .	Luminaire with neutral white colour temperature (4000 K)
. 1 . .	Dimmable luminaire (DALI)
. 2 . .	Dimmable luminaire (1-10 V)

The luminaires can be supplied with asymmetrical light distribution upon request.

LED (see page 247)

Luminaires available in 2700 K and other colour temperatures on request

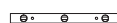

System examples

To calculate the overall length of the system, the lengths of the individual luminaire modules and the dimensions of the connection flanges or arms must be added together.

By combining luminaires of different lengths, the overall length of the system can be made to coincide with the dimensions of the surface to be illuminated.

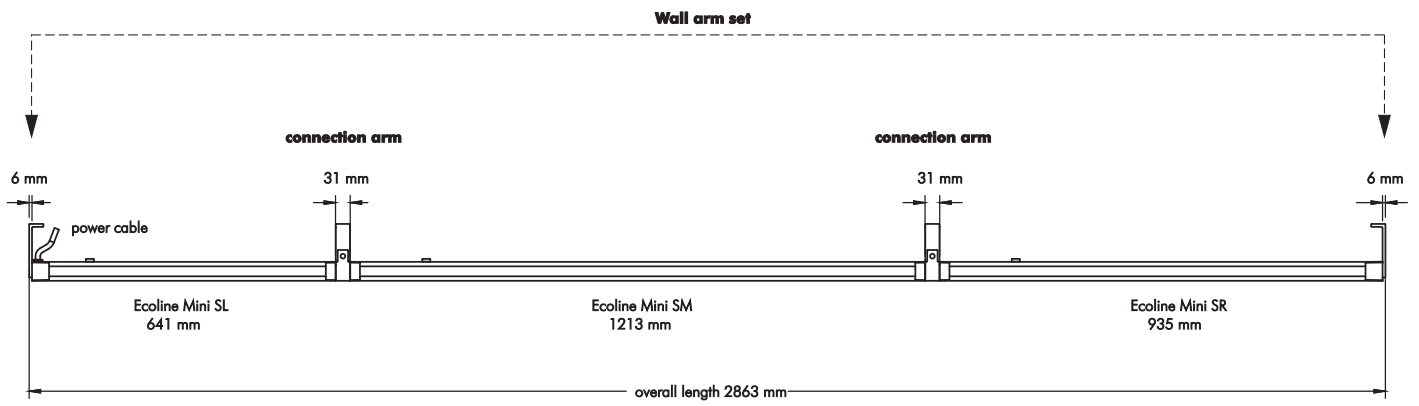
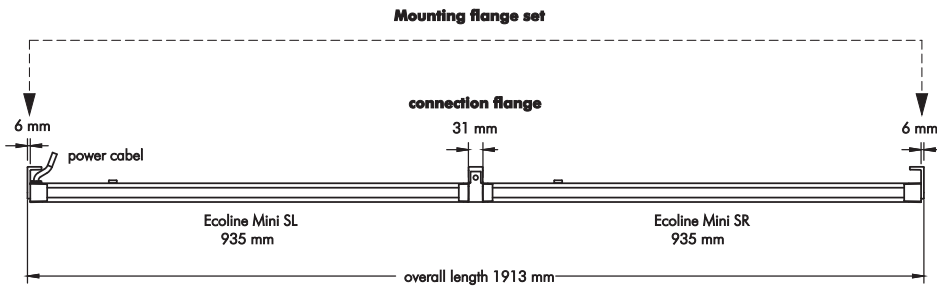

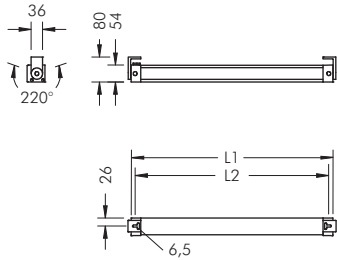

Ecoline wall washer

With high performance LEDs, integral temperature monitoring device, CRI: > 80, Colour tolerance: max. 2 SDCM Service life: L90/B10 > 50 000 h protection class I, IP67 IK10 housing made of extruded aluminium and corrosion-resistant die cast aluminium housing AlSi12, polyester powder coated, all exterior steel parts are stainless steel, polycarbonate cover, silicon gasket, closure by 2 stainless steel screws, mounting flanges: 2 drilled holes Ø 6.5 mm, spacing L2, tilt range 220°, M20 cable gland, integral driver (AC/DC)

Ecoline, wall washer, L1 = 362 mm, L2 = 315 mm

Part number	Colour	Weight	Light source	Luminous flux	Beam angle γ (FWHM)	
8 792 946 009	black	1.7 kg	3 x LED 2.5 W (8 W)	533 lm	C 0 – 180	C 90 – 270
8 792 966 009	white				12°	108°
8 792 956 009	silver grey					

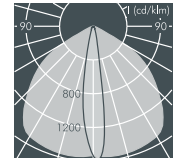
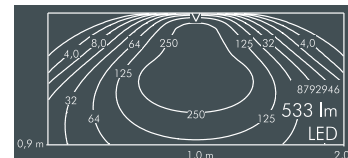

Part number	Colour	Weight	Light source	Luminous flux	Beam angle γ (FWHM)	
8 792 945 009	black	1.7 kg	3 x LED 2.5 W (8 W)	570 lm	C 0 – 180	C 90 – 270
8 792 965 009	white				12°	108°
8 792 955 009	silver grey					

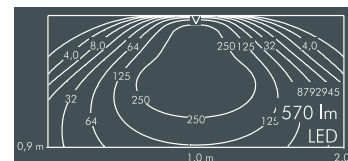

Ecoline, wall washer, L1 = 662 mm, L2 = 615 mm

Part number	Colour	Weight	Light source	Luminous flux	Beam angle γ (FWHM)	
8 792 046 009	black	2.3 kg	6 x LED 2.5 W (15 W)	1059 lm	C 0 – 180	C 90 – 270
8 792 066 009	white				12°	108°
8 792 056 009	silver grey					

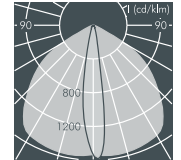
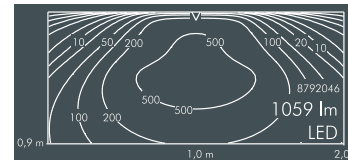

Part number	Colour	Weight	Light source	Luminous flux	Beam angle γ (FWHM)	
8 792 045 009	black	2.3 kg	6 x LED 2.5 W (15 W)	1133 lm	C 0 – 180	C 90 – 270
8 792 065 009	white				12°	108°
8 792 055 009	silver grey					

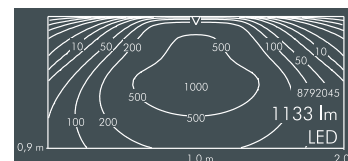

Ecoline, wall washer, L1 = 962 mm, L2 = 915 mm

Part number	Colour	Weight	Light source	Luminous flux	Beam angle γ (FWHM)	
8 792 146 009	black	3.1 kg	9 x LED 2.5 W (23 W)	1588 lm	C 0 – 180	C 90 – 270
8 792 166 009	white				12°	108°
8 792 156 009	silver grey					

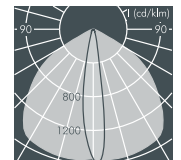
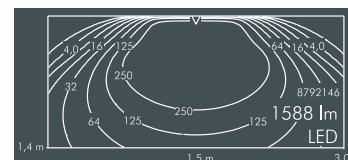

Part number	Colour	Weight	Light source	Luminous flux	Beam angle γ (FWHM)	
8 792 145 009	black	3.1 kg	9 x LED 2.5 W (23 W)	1699 lm	C 0 – 180	C 90 – 270
8 792 165 009	white				12°	108°
8 792 155 009	silver grey					

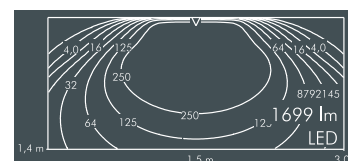

Part number**	Description
. 1..	Dimmable luminaire (DALI)*
. 2..	Dimmable luminaire (1-10 V)*

*Not available for luminaire L1 = 362 mm
**Luminaires with two cable glands available upon request

LED (see page 247)
Luminaires available in 2700 K and other colour temperatures upon request

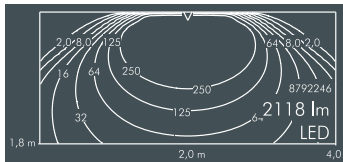
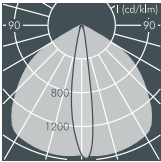

Ecoline, wall washer, L1 = 1262 mm, L2 = 1215 mm

Part number	Colour	Weight	Light source	Luminous flux	Beam angle γ (FWHM)	
8 792 246 009	black	3.6 kg	12 x LED 2.5 W (30 W)	2118 lm	C 0 – 180	C 90 – 270
8 792 266 009	white				12°	108°
8 792 256 009	silver grey					

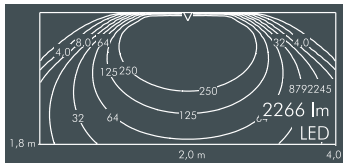

Part number	Colour	Weight	Light source	Luminous flux	Beam angle γ (FWHM)	
8 792 245 009	black	3.6 kg	12 x LED 2.5 W (30 W)	2266 lm	C 0 – 180	C 90 – 270
8 792 265 009	white				12°	108°
8 792 255 009	silver grey					

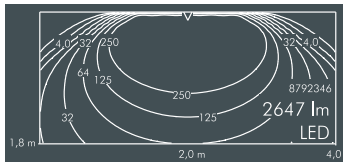
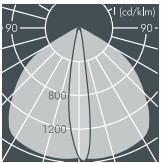

Ecoline, wall washer, L1 = 1562 mm, L2 = 1515 mm

Part number	Colour	Weight	Light source	Luminous flux	Beam angle γ (FWHM)	
8 792 346 009	black	4.2 kg	15 x LED 2.5 W (38 W)	2647 lm	C 0 – 180	C 90 – 270
8 792 366 009	white				12°	108°
8 792 356 009	silver grey					

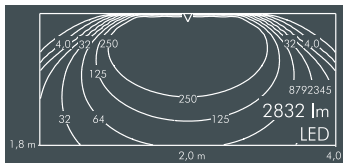

Part number	Colour	Weight	Light source	Luminous flux	Beam angle γ (FWHM)	
8 792 345 009	black	4.2 kg	15 x LED 2.5 W (38 W)	2832 lm	C 0 – 180	C 90 – 270
8 792 365 009	white				12°	108°
8 792 355 009	silver grey					



Ecoline, narrow beam**

Part number	Description
. 1.	Luminaires with narrow beam distribution

**The luminaires are available in 3 different lengths: L1 = 362/662/962 mm

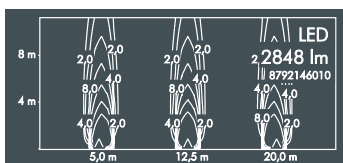
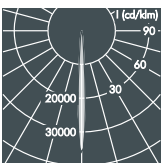

Ecoline, narrow beam, L1 = 962 mm, L2 = 915 mm

Part number	Colour	Weight	Light source	Luminous flux	Beam angle γ (FWHM)
8 792 146 019	black	3.1 kg	17 x LED 2.5 W (42 W)	2848 lm	7°
8 792 166 019	white				
8 792 156 019	silver grey				



Ecoline, asymmetrical beam**

Part number	Description
. 8.	Luminaires with asymmetrical distribution

**The luminaires are available in 5 different lengths.

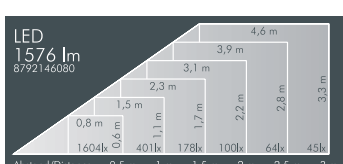
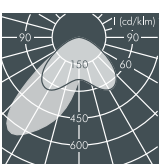

Ecoline, asymmetrical beam, L1 = 962 mm, L2 = 915 mm

Part number	Colour	Weight	Light source	Luminous flux	Main beam angle γ
8 792 146 089	black	3.1 kg	9 x LED 2.5 W (23 W)	1576 lm	36°
8 792 166 089	white				
8 792 156 089	silver grey				



Ecoline, wide beam**

Part number	Description
. 5.	Luminaires with wide beam distribution

**The luminaires are available in 5 different lengths.

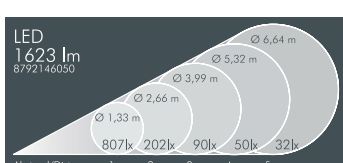
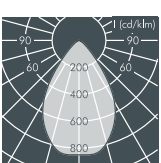

Ecoline, wide beam, L1 = 962 mm, L2 = 915 mm

Part number	Colour	Weight	Light source	Luminous flux	Beam angle γ (FWHM)
8 792 146 059	black	3.1 kg	9 x LED 2.5 W (23 W)	1623 lm	67°
8 792 166 059	white				
8 792 156 059	silver grey				

Part number**	Description
. 1..	Dimmable luminaire (DALI)*
. 2..	Dimmable luminaire (1-10 V)*

*Not available for luminaire L1 = 362 mm

**Luminaires with two cable glands available upon request

LED (see page 247)

Luminaires available in 2700 K and other colour temperatures upon request



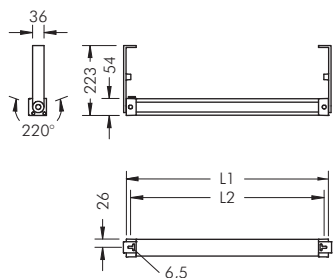

Ecoline wall washer with wall arms

With high performance LEDs, integral temperature monitoring device, CRI: > 80, Colour tolerance: max. 2 SDCM
 Service life: L90/B10 > 50 000 h
 protection class I, IP67 IK10
 housing made of extruded aluminium and corrosion-resistant die cast aluminium housing AlSi12, all exterior steel parts are stainless steel, polycarbonate cover, silicon gasket, closure by 2 stainless steel screws, wall arms: 2 drilled holes Ø 6.5 mm, spacing L2, tilt range 220°, M20 cable gland, integral driver (AC/DC)

Ecoline, wall washer with wall arms, L1 = 362 mm, L2 = 315 mm

Part number	Colour	Weight	Light source	Luminous flux	Beam angle γ (FWHM)	
8 793 946 009	black	2.2 kg	3 x LED 2.5 W (8 W)	533 lm	C 0 – 180	C 90 – 270
8 793 966 009	white				12°	108°
8 793 956 009	silver grey					

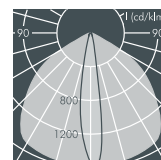
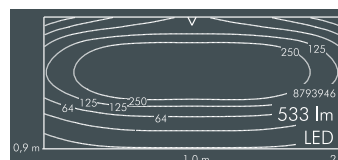

Part number	Colour	Weight	Light source	Luminous flux	Beam angle γ (FWHM)	
8 793 945 009	black	2.2 kg	3 x LED 2.5 W (8 W)	570 lm	C 0 – 180	C 90 – 270
8 793 965 009	white				12°	108°
8 793 955 009	silver grey					

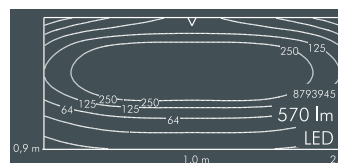

Ecoline, wall washer with wall arms, L1 = 662 mm, L2 = 615 mm

Part number	Colour	Weight	Light source	Luminous flux	Beam angle γ (FWHM)	
8 793 046 009	black	2.8 kg	6 x LED 2.5 W (15 W)	1059 lm	C 0 – 180	C 90 – 270
8 793 066 009	white				12°	108°
8 793 056 009	silver grey					

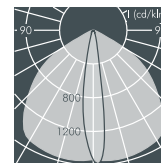
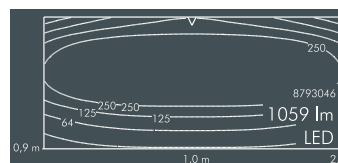

Part number	Colour	Weight	Light source	Luminous flux	Beam angle γ (FWHM)	
8 793 045 009	black	2.8 kg	6 x LED 2.5 W (15 W)	1133 lm	C 0 – 180	C 90 – 270
8 793 065 009	white				12°	108°
8 793 055 009	silver grey					

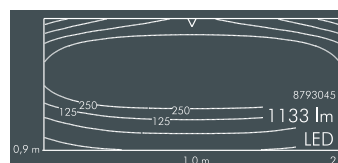

Ecoline, wall washer with wall arms, L1 = 962 mm, L2 = 915 mm

Part number	Colour	Weight	Light source	Luminous flux	Beam angle γ (FWHM)	
8 793 146 009	black	3.6 kg	9 x LED 2.5 W (23 W)	1588 lm	C 0 – 180	C 90 – 270
8 793 166 009	white				12°	108°
8 793 156 009	silver grey					

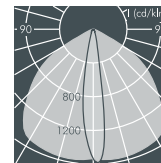
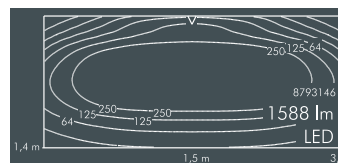

Part number	Colour	Weight	Light source	Luminous flux	Beam angle γ (FWHM)	
8 793 145 009	black	3.6 kg	9 x LED 2.5 W (23 W)	1699 lm	C 0 – 180	C 90 – 270
8 793 165 009	white				12°	108°
8 793 155 009	silver grey					

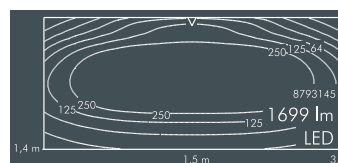

Part number**	Description
. 1..	Dimmable luminaire (DALI)*
. 2..	Dimmable luminaire (1-10 V)*

*Not available for luminaire L1 = 362 mm

**Luminaires with two cable glands available upon request

LED (see page 247)

Luminaires available in 2700 K and other colour temperatures upon request

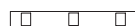

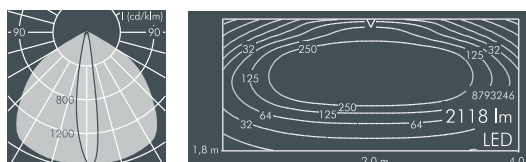

Ecoline, wall washer with wall arms, L1 = 1262 mm, L2 = 1215 mm

Part number	Colour	Weight	Light source	Luminous flux	Beam angle γ (FWHM)	
8 793 246 009	black	4.1 kg	12 x LED 2.5 W (30 W)	2118 lm	C 0 – 180	C 90 – 270
8 793 266 009	white				12°	108°
8 793 256 009	silver grey					

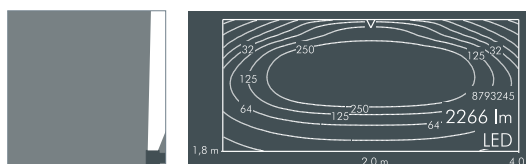

Part number	Colour	Weight	Light source	Luminous flux	Beam angle γ (FWHM)	
8 793 245 009	black	4.1 kg	12 x LED 2.5 W (30 W)	2266 lm	C 0 – 180	C 90 – 270
8 793 265 009	white				12°	108°
8 793 255 009	silver grey					

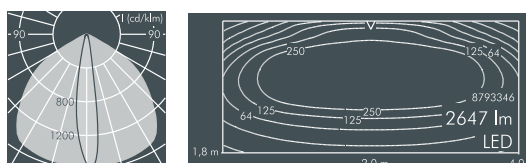

Ecoline, wall washer with wall arms, L1 = 1562 mm, L2 = 1515 mm

Part number	Colour	Weight	Light source	Luminous flux	Beam angle γ (FWHM)	
8 793 346 009	black	4.7 kg	15 x LED 2.5 W (38 W)	2647 lm	C 0 – 180	C 90 – 270
8 793 366 009	white				12°	108°
8 793 356 009	silver grey					

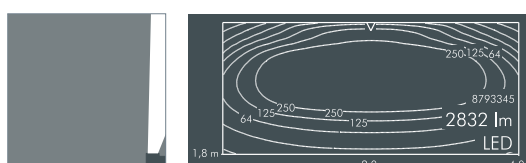

Part number	Colour	Weight	Light source	Luminous flux	Beam angle γ (FWHM)	
8 793 345 009	black	4.7 kg	15 x LED 2.5 W (38 W)	2832 lm	C 0 – 180	C 90 – 270
8 793 365 009	white				12°	108°
8 793 355 009	silver grey					



Ecoline, narrow beam with wall arms**

Part number	Description
. 1.	Luminaires with narrow beam distribution

**The luminaires are available in 3 different lengths: L1 = 362/662/962 mm

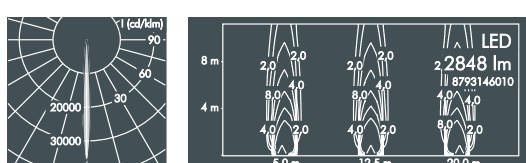

Ecoline, narrow beam with wall arms, L1 = 962 mm, L2 = 915 mm

Part number	Colour	Weight	Light source	Luminous flux	Beam angle γ (FWHM)
8 793 146 019	black	3.6 kg	17 x LED 2.5 W (42 W)	2848 lm	7°
8 793 166 019	white				
8 793 156 019	silver grey				



Ecoline, asymmetrical beam with wall arms**

Part number	Description
. 8.	Luminaires with asymmetrical distribution

**The luminaires are available in 5 different lengths.

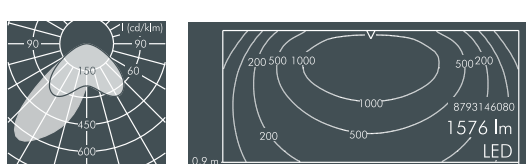

Ecoline, asymmetrical beam with wall arms, L1 = 962 mm, L2 = 915 mm

Part number	Colour	Weight	Light source	Luminous flux	Main beam angle γ
8 793 146 089	black	3.6 kg	9 x LED 2.5 W (23 W)	1576 lm	36°
8 793 166 089	white				
8 793 156 089	silver grey				



Ecoline, wide beam with wall arms**

Part number	Description
. 5.	Luminaires with wide beam distribution

**The luminaires are available in 5 different lengths.

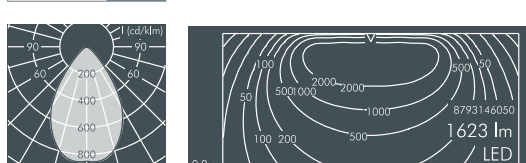

Ecoline, wide beam with wall arms, L1 = 962 mm, L2 = 915 mm

Part number	Colour	Weight	Light source	Luminous flux	Beam angle γ (FWHM)
8 793 146 059	black	3.6 kg	9 x LED 2.5 W (23 W)	1623 lm	67°
8 793 166 059	white				
8 793 156 059	silver grey				

Part number**	Description
. 1..	Dimmable luminaire (DALI)*
. 2..	Dimmable luminaire (1-10 V)*

*Not available for luminaire L1 = 362 mm

**Luminaires with two cable glands available upon request

LED (see page 247)

Luminaires available in 2700 K and other colour temperatures upon request





Ecoline S Modular System

The luminaire modules are joined together in continuous runs. The luminaire system is installed using either wall flanges or wall arms. The wall arms increase the distance between the luminaire and the surface to be illuminated, thus increasing the uniformity of light distribution.

Regardless of the number of luminaires to be connected, just 1 wall flange set **or** 1 wall arm set is required to mount the outer left and right hand luminaires, SL and SR, to the surface.

Mounting components for Ecoline S Modular System

Part number	Colour	Description
127 0 299 940	black	Wall flange set, (pair) for outer luminaires
127 0 299 960	white	
127 0 299 950	silver grey	

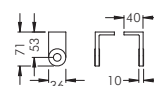

6,5

Mounting components for Ecoline S Modular System

Part number	Colour	Description
127 0 300 940	black	Wall arm set, (pair) for outer luminaires, length 196 mm
127 0 300 960	white	
127 0 300 950	silver grey	

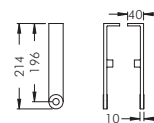

6,5

To connect two luminaires together, either one connection flange **or** one connection arm is required. The number of these connection parts required equals the total number of luminaires minus 1.

Mounting components for Ecoline S Modular System

Part number	Colour	Description
127 0 301 940	black	Connection flange, c/w 3-core cable for through wiring, for connection of 2 luminaires
127 0 301 960	white	
127 0 301 950	silver grey	

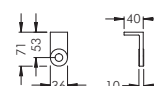

6,5

Part number	Colour	Description
127 0 332 940	black	Connection flange for dimmable luminaire, c/w 5-core cable for through wiring, for connection of 2 luminaires
127 0 332 960	white	
127 0 332 950	silver grey	

Mounting components for Ecoline S Modular System

Part number	Colour	Description
127 0 302 940	black	Connection arm c/w 3-core cable for through wiring, for connection of 2 luminaires, length 196 mm
127 0 302 960	white	
127 0 302 950	silver grey	

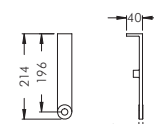

6,5

Part number	Colour	Description
127 0 333 940	black	Connection arm for dimmable luminaire, c/w 5-core cable for through wiring, for connection of 2 luminaires, length 196 mm
127 0 333 960	white	
127 0 333 950	silver grey	

The Modular System

Luminaires of different lengths and wattages can be connected together. One left (SL) and one right hand (SR) luminaire are always required. In addition to these, middle luminaires (SM) can be added to the system.

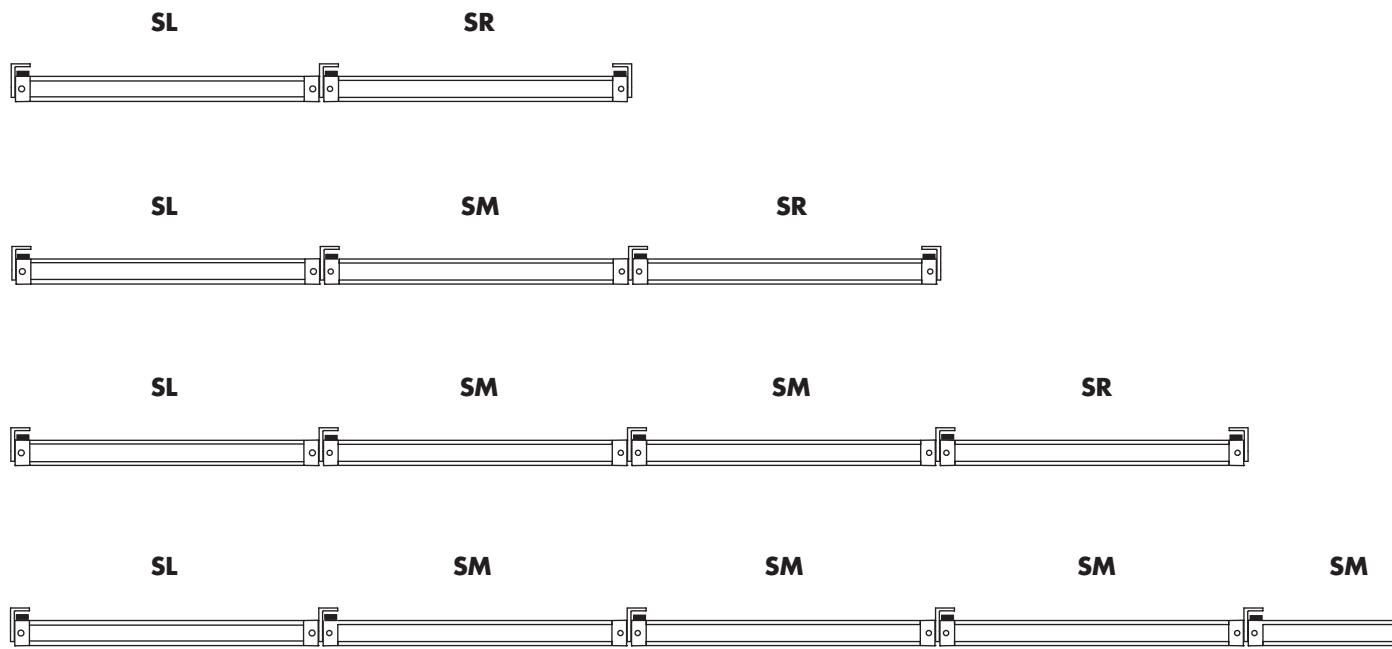

■ **Cable gland** (on rear side)



Ecoline SL Modular System, left

One cable entry on the left



Ecoline SM Modular System, middle

One cable entry on the left



Ecoline SR Modular System, right

Two cable entries right and left

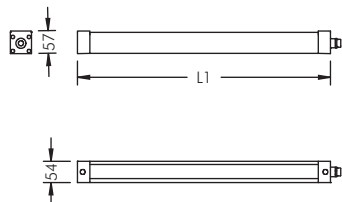

Ecoline SL Modular System left

With high performance LEDs, integral temperature monitoring device, wall washer light distribution, CRI: > 80, Colour tolerance: max. 2 SDCM Service life: L90/B10 > 50 000 h protection class I, IP65 , IK10 housing made of extruded aluminium and corrosion-resistant die cast aluminium housing AlSi12, polyester powder coated, all exterior steel parts are stainless steel, polycarbonate cover, silicon gasket, closure by 2 stainless steel screws, with stainless steel coupling on right side, tilt range 220°, M20 cable gland, integral driver (AC/DC)

Ecoline SL, left, wall washer, L1 = 642 mm

Part number	Colour	Weight	Light source	Luminous flux	Beam angle γ (FWHM)	
8 797 046 009	black	2.3 kg	6 x LED 2.5 W (15 W)	1059 lm	C 0 – 180	C 90 – 270
8 797 066 009	white				12°	108°
8 797 056 009	silver grey					

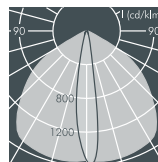

Ecoline SL, left, wall washer, L1 = 942 mm

Part number	Colour	Weight	Light source	Luminous flux	Beam angle γ (FWHM)	
8 797 146 009	black	2.9 kg	9 x LED 2.5 W (23 W)	1588 lm	C 0 – 180	C 90 – 270
8 797 166 009	white				12°	108°
8 797 156 009	silver grey					

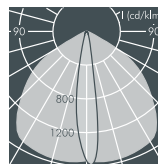

Ecoline SL, left, wall washer, L1 = 1242 mm

Part number	Colour	Weight	Light source	Luminous flux	Beam angle γ (FWHM)	
8 797 246 009	black	3.4 kg	12 x LED 2.5 W (30 W)	2118 lm	C 0 – 180	C 90 – 270
8 797 266 009	white				12°	108°
8 797 256 009	silver grey					

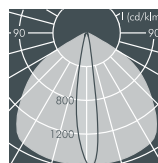

Ecoline SL, left, wall washer, L1 = 1542 mm

Part number	Colour	Weight	Light source	Luminous flux	Beam angle γ (FWHM)	
8 797 346 009	black	4.0 kg	15 x LED 2.5 W (38 W)	2647 lm	C 0 – 180	C 90 – 270
8 797 366 009	white				12°	108°
8 797 356 009	silver grey					

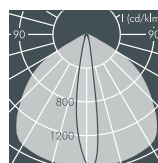

Ecoline SL, left, wall washer

Part number	Description
. 5 . . .	Luminaire with neutral white colour temperature (4000 K)
. 1 . .	Dimmable luminaire (DALI)
. 2 . .	Dimmable luminaire (1-10 V)



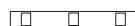

The luminaires can be supplied with wide beam or asymmetrical light distribution upon request.

LED (see page 247)

Luminaires available in 2700 K and other colour temperatures upon request



Ecoline SM Modular System middle

With high performance LEDs,
integral temperature monitoring device,
wall washer light distribution,
CRI: > 80, Colour tolerance: max. 2 SDCM
Service life: L90/B10 > 50 000 h
protection class I, IP65    , IK10
housing made of extruded aluminium and
corrosion-resistant die cast aluminium housing AlSi12,
polyester powder coated,
all exterior steel parts are stainless steel,
polycarbonate cover, silicon gasket,
closure by 2 stainless steel screws,
with stainless steel couplings on left and right side,
tilt range 220°, M20 cable gland,
integral driver (AC/DC)

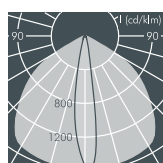
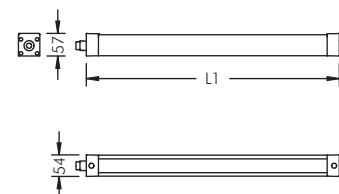

Ecoline SM, middle, wall washer, L1 = 642 mm

Part number	Colour	Weight	Light source	Luminous flux	Beam angle γ (FWHM)	
8 798 046 009	black	2.3 kg	6 x LED 2.5 W (15 W) warm white (3000 K)	1059 lm	C 0 – 180	C 90 – 270
8 798 066 009	white				12°	108°
8 798 056 009	silver grey					

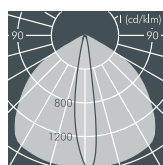

Ecoline SM, middle, wall washer, L1 = 942 mm

Part number	Colour	Weight	Light source	Luminous flux	Beam angle γ (FWHM)	
8 798 146 009	black	2.9 kg	9 x LED 2.5 W (23 W) warm white (3000 K)	1588 lm	C 0 – 180	C 90 – 270
8 798 166 009	white				12°	108°
8 798 156 009	silver grey					

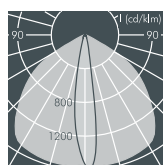

Ecoline SM, middle, wall washer, L1 = 1242 mm

Part number	Colour	Weight	Light source	Luminous flux	Beam angle γ (FWHM)	
8 798 246 009	black	3.4 kg	12 x LED 2.5 W (30 W) warm white (3000 K)	2118 lm	C 0 – 180	C 90 – 270
8 798 266 009	white				12°	108°
8 798 256 009	silver grey					

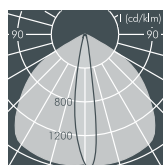

Ecoline SM, middle, wall washer, L1 = 1542 mm

Part number	Colour	Weight	Light source	Luminous flux	Beam angle γ (FWHM)	
8 798 346 009	black	4.0 kg	15 x LED 2.5 W (38 W) warm white (3000 K)	2647 lm	C 0 – 180	C 90 – 270
8 798 366 009	white				12°	108°
8 798 356 009	silver grey					

Ecoline SM, middle, wall washer

Part number	Description
... 5 ...	Luminaire with neutral white colour temperature (4000 K)
... 1 ..	Dimmable luminaire (DALI)
... 2 ..	Dimmable luminaire (1-10 V)

The luminaires can be supplied with wide beam or asymmetrical light distribution upon request.



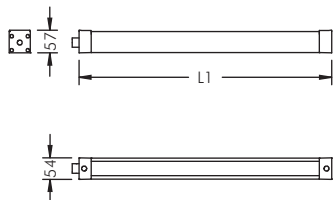

LED (see page 247)

Luminaires available in 2700 K and other colour temperatures upon request





Ecoline SR Modular System right

With high performance LEDs, integral temperature monitoring device, wall washer light distribution, CRI: > 80, Colour tolerance: max. 2 SDCM Service life: L90/B10 > 50 000 h protection class I, IP65    , IK10 housing made of extruded aluminium and corrosion-resistant die cast aluminium housing AlSi12, polyester powder coated, all exterior steel parts are stainless steel, polycarbonate cover, silicon gasket, closure by 2 stainless steel screws, with stainless steel coupling on left side, tilt range 220°, M20 cable gland, integral driver (AC/DC)

Ecoline SR, right, wall washer, L1 = 642 mm

Part number	Colour	Weight	Light source	Luminous flux	Beam angle γ (FWHM)	
8 799 046 009	black	2.3 kg	6 x LED 2.5 W (15 W)	1059 lm	C 0 – 180	C 90 – 270
8 799 066 009	white				12°	108°
8 799 056 009	silver grey					

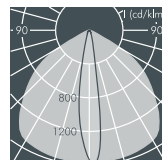

Ecoline SR, right, wall washer, L1 = 942 mm

Part number	Colour	Weight	Light source	Luminous flux	Beam angle γ (FWHM)	
8 799 146 009	black	2.9 kg	9 x LED 2.5 W (23 W)	1588 lm	C 0 – 180	C 90 – 270
8 799 166 009	white				12°	108°
8 799 156 009	silver grey					

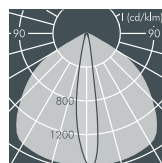

Ecoline SR, right, wall washer, L1 = 1242 mm

Part number	Colour	Weight	Light source	Luminous flux	Beam angle γ (FWHM)	
8 799 246 009	black	3.4 kg	12 x LED 2.5 W (30 W)	2118 lm	C 0 – 180	C 90 – 270
8 799 266 009	white				12°	108°
8 799 256 009	silver grey					

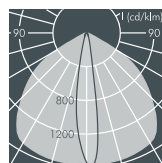

Ecoline SR, right, wall washer, L1 = 1542 mm

Part number	Colour	Weight	Light source	Luminous flux	Beam angle γ (FWHM)	
8 799 346 009	black	4.0 kg	15 x LED 2.5 W (38 W)	2647 lm	C 0 – 180	C 90 – 270
8 799 366 009	white				12°	108°
8 799 356 009	silver grey					

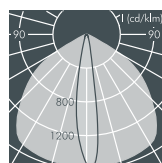

Ecoline SR, right, wall washer

Part number	Description
. 5 . . .	Luminaire with neutral white colour temperature (4000 K)
. 1 . .	Dimmable luminaire (DALI)
. 2 . .	Dimmable luminaire (1-10 V)

The luminaires can be supplied with wide beam or asymmetrical light distribution upon request.

LED (see page 247)

Luminaires available in 2700 K and other colour temperatures upon request

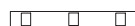

System examples

To calculate the overall length of the system, the lengths of the individual luminaire modules and the dimensions of the connection flanges or arms must be added together.

By combining luminaires of different lengths, the overall length of the system can be made to coincide with the dimensions of the surface to be illuminated.

